

Optem® Zoom 160 16:1 Micro-Inspection Zoom Lens System

The Optem Zoom 160 represents the ultimate optical performance of micro-inspection zoom optics available today. Featuring an expansive 16:1 zoom range, this premium Lens System delivers up to 0.31 numerical aperture and 915 lp/mm from a versatile modular lens package. Zoom 160 is the perfect solution when capturing the finest details of your subject is mission critical.

With its extended zoom range and pinpoint resolving power, the Zoom 160 can be easily configured to deliver optical performance rivaling that of benchtop research microscopes. Combine this performance with the added versatility of 16:1 zoom, four-piece modular design flexibility, automatable functionality, and you have a powerful Lens System worthy of today's advanced-definition camera technology.

Base Configuration (1X TV Tube + 1X Obj. Lens)	(@ Low Mag.)	(@ High Mag.)
Magnification Range	0.50X	8.0X
Numerical Aperture	0.0095	0.15
Resolution	29 lp/mm	462 lp/mm
Depth-of-Field	6.2 mm	0.024 mm
Working Distance	89 mm	89 mm
FOV (1/3" Camera)	7.2 x 9.6 mm	0.45 x 0.60 mm
FOV (1/2" Camera)	9.6 x 12.8 mm	0.60 x 0.80 mm
FOV (2/3" Camera)	13.2 x 17.6 mm	0.83 x 1.10 mm
FOV (1" Camera)	19.2 x 25.6 mm	1.20 x 1.60 mm
Min. Configuration (.375X TV Tube with .25X Obj. Lens)	(@ Low Mag.)	(@ High Mag.)
Magnification Range	0.047X	0.75X
Numerical Aperture	0.0023	0.038
Resolution	7 lp/mm	113 lp/mm
Depth-of-Field	104 mm	0.40 mm
Working Distance	370 mm	370 mm
Max. Configuration (2X TV Tube + 2X Obj. Lens)	(@ Low Mag.)	(@ High Mag.)
Magnification Range	2.0X	32.0X
Numerical Aperture	0.018	0.31
Resolution	562 lp/mm	915 lp/mm
Depth-of-Field	1.6 mm	0.0061 mm
Working Distance	33 mm	33 mm



Specifying Your Optem Lens System

To specify your Optem Lens System identify the parameters of your application and select the modular components which deliver the optimum imaging solution.

STEP 1. Determine the Field-of-View (FOV) you require by choosing your intended camera format (1/3", 1/2", 2/3" etc.), and using the dimensions of that camera format to calculate the optical magnification required (see camera dimensions below):

$$\text{Optical Mag.} = \frac{\text{Camera dimension (mm)}}{\text{FOV desired (mm)}}$$

STEP 2. The Zoom 160 **base configuration** consists of a Manual Zoom, a Basic Lower Function Module, a 1X TV Tube, and a 1X Objective Lens, yielding an optical magnification range of 0.5X - 8.0X.

Given your optical magnification requirement from STEP 1, determine if your needs fall into the **base configuration** range of 0.5X - 8.0X. If you require higher than 8.0X optical magnification, you can change to an Objective Lens with a magnification factor greater than 1X, AND/OR you can choose a TV Tube with a magnification factor greater than 1X (keeping in mind that Objective Lenses affect the working distance of the system and TV Tubes do not).

Referring to the [Optical Performance Charts \(p. 6-7\)](#), you can select the best combination of Objective Lens and TV Tube to best meet the parameters of your application.

STEP 3. Select the Upper Zoom Module: The upper module has the following options available: Manual, Detents and Motorized (see [System Diagram p. 10-11](#)).

Select the Lower Function Module: Lower Function Modules integrate the features and functions desired in your lens system beyond zoom function: coaxial illumination, internal focus (manual/motor) (see [System Diagram p. 10-11](#)).

STEP 4. When completed, you will have identified the following four components required for your functional Zoom 160 Lens System.

- 1) TV Tube
- 2) Upper Zoom Module
- 3) Lower Function Module
- 4) Objective Lens (required)

Optem Lens Systems are specifically designed to deliver maximum versatility for your micro-inspection needs. If you do not see a standard configuration that meets your requirements, Qioptiq offers efficient and affordable custom modifications to meet special parameters.

Useful Formulas & Definitions

CAMERA CHIP DIMENSIONS (mm):

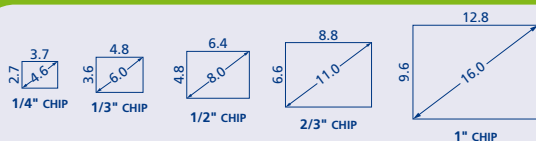

DEPTH-OF-FIELD (DOF):

The axial depth of the space on both sides of the object plane within which the object can be moved without objectionable loss of sharpness.

$$\text{DOF} = \lambda \div \text{NA}^2$$

λ = Wavelength of Light (Green Light = 0.000550mm or 550nm)

MAGNIFICATION:

The ratio of image size to actual object size.

$$\text{Optical Mag.} = \text{Camera Chip dim.} \div \text{Field-of-View (FOV)}$$

$$\text{Electronic Mag.} = \text{Monitor Diag.} \div \text{Camera Diag.}$$

NUMERICAL APERTURE (NA):

A measurement of the light collecting ability of the lens. A higher NA translates to a brighter image, better resolution, and shallower depth-of-field.

Zoom and Function Modules

Upper Zoom Modules



The Upper Zoom Module determines the mechanical nature of your zoom function. All Zoom 160 Upper Zoom Modules come standard with an iris diaphragm for better light level and depth of field control.

MANUAL ZOOM MODULE – Provides an economical hand-driven 16:1 zoom function.



DETENT MODULE – Offers repeatable magnification stops throughout the 16:1 zoom range without the complexity and cost of motorization. Detents are ideal for metrology applications where each position can be calibrated. Factory-set stops are located at 0.5X, 1.0X, 2.0X, 3.0X, 4.0X, 5.0X, 6.0X, 7.0X and 8.0X.



MOTORIZED ZOOM MODULE – Provides automated zoom in either DC or Stepper Motorized Versions. All Stepper Motorized Models come complete with homing and limit sensors.

Lower Function Modules

Select from 12 Lower Modules to provide a variety of illumination and focusing options to your Zoom 160. Lower Modules can be attached below a Zoom 160 Upper Module by simply tightening three set screws with the provided allen wrench.

BASIC MODULES – The Basic Lower Function Module provides the capability of attaching Objective Lenses to a Zoom 160.



INTERNAL 15MM FINE FOCUS MODULES – Ideal for applications without separate focusing support systems. Provides the ability to focus over a 15mm axial distance at the object. Available in manual and motorized options.



COAXIAL ILLUMINATION MODULES – This Module provides a port for the injection of incident light. Available with Internal 5mm Focus in manual or motorized options. All Coaxial Lower Modules are available with an optional, built-in Analyzer for polarized light applications. A Polarizer (30-36-03-000), and a 1/4 Wave Plate (30-36-04-000) are recommended for optimal performance when using the Analyzer (see System Diagram p. 10-11).



RESOLUTION:

The ability to distinguish or separate fine detail. Expressed in line pairs per millimeter (lp/mm). Numerical Aperture (NA) is the controlling factor over resolution... the higher the NA, the brighter the image, and the better the resolution.

$$\text{Visual Resolution (lp/mm)} = 3000 \times \text{NA}$$
$$1 \div \text{lp/mm} = \text{Approx. microns } (\mu) \text{ resolved}$$

VIGNETTING:

The blockage of rays from off-axis object points by constraining apertures. Vignetting results in the darkening of the corners on your monitor.



Illumination Options



Illumination Options

The Zoom 160 Lens System offers a variety of illumination options to meet a variety of imaging requirements. You have two basic illumination options which can be integrated with your Zoom 160 System... coaxial illumination or oblique ring light illumination.

Oblique Ring light Options

Dark Field Illumination is generally used on 3-D objects to cast light rays at an angle onto an object, thus better defining its surface profile. Optem offers the following dark field illuminators for the Zoom 160 System.

FIBER OPTIC RING LIGHTS – Oblique Ring light Illumination is ideal to better define features of dimension rich subjects. Zoom 160 Ring lights include a 36" fiber bundle and integrate with your choice of either 110V or 220V Optem VSI Fiber Optic Illuminators.

Coaxial Illumination Options

Coaxial (or vertical) illumination is most useful on highly reflective objects. Optem's Coaxial Illuminators project cool, white light perpendicularly onto the specimen for exceptional contrast and field uniformity.

LED COAXIAL ILLUMINATORS –

1-Watt LED Coaxial Illuminators offer reduced power requirements and heat generation with substantial service life gains. For the Zoom 160, LED Coaxial illuminators feature compact designs and simplified cable



management, and are available in Straight and Right-angle options to meet specific space requirements. These can be driven by stand-alone, single-channel programmable controllers. Coaxial LEDs emit brilliant cool light in the visible spectrum.

Select from one of several coaxial-equipped lower function modules when specifying your Zoom 160 Lens System and integrate one of the three following options of coaxial illumination.

FIBER OPTIC COAXIAL ILLUMINATORS – Integrate coaxial illumination from your choice of either 110V or 220V Optem VSI Fiber Optic Illuminators using flexible 40- or 60-inch flexible fiber bundles.



10W HALOGEN COAXIAL ILLUMINATORS – When economy is high priority, Halogen light sources are available with a 6V Variable Transformer (110V / 220V).

POLARIZED LIGHT – When imaging highly reflective subjects, Polarizer Modules with built-in Analyzers are available to introduce polarization to both LED and Fiber Optic Coaxial Illumination paths.

Motorization Accessories



Motorizing Lens System

Optem Lens Systems can be specified with motorized zoom and/or focus functions.

DC MOTOR – DC motors provide continuous control of zoom magnification and/or focus. A desktop joystick controller offers simultaneous control of both zoom and focus functions.



STEPPER MOTOR – The stepper motors provide accurate repeatability of zoom magnification and/or focus using a Hall-effect sensor to set repeatable home position. A desktop rocker switch controller offers manual control and features an RS-232 port for automated computer control. Includes controller instructions with a list of RS-232 control commands, a Windows® control program, and startup LabVIEW control program.

05

An OEM controller board version is available for streamlined integration.

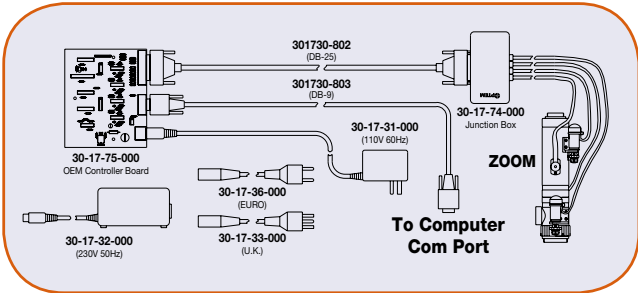

Optical Performance - Oblique/Substage Illumination

	0.25X Objective Lens 30-37-28-000 WD: 370 mm			0.5X Objective Lens 30-37-29-000 WD: 181 mm			0.75X Objective Lens 30-37-30-000 WD: 118 mm			1.0X Objective Lens 30-37-31-000 WD: 89 mm			1.5X Objective Lens 30-37-32-000 WD: 55 mm			2.0X Objective Lens 30-37-34-000 WD: 33 mm		
	Low Mag	High Mag	FOV (mm)	Low Mag	High Mag	FOV (mm)	Low Mag	High Mag	FOV (mm)	Low Mag	High Mag	FOV (mm)	Low Mag	High Mag	FOV (mm)	Low Mag	High Mag	FOV (mm)
0.375X TV Tube	NA	0.0023	76.8 x 102	0.038	0.0047	38.4 x 51.2	0.076	0.0071	19.2 x 25.6	0.15	0.014	9.6 x 12.8	0.019	0.011	4.8 x 6.4	0.0061	0.31	0.80
	Res (lp/mm)	7	113	14	228	28	462	21	348	29	462	29	462	29	462	29	462	29
	Mag	0.047	0.75	0.094	1.50	2.3	3.00	0.19	0.28	0.45	0.28	0.45	0.38	0.28	0.45	0.38	0.28	0.45
	DOF (mm)	104	0.40	26	0.098	11	0.042	6.2	0.024	2.8	0.011	1.6	0.019	0.011	1.6	0.0061	0.31	0.80
	1/3*	102 x 137	6.40 x 8.53	51.2 x 68.3	3.20 x 4.27	34.1 x 45.5	2.13 x 2.84	1.60 x 2.13	1.20 x 1.60	0.90 x 1.20	0.60 x 0.80	0.45 x 0.60	0.30 x 0.40	0.20 x 0.27	0.15 x 0.20	0.10 x 0.15	0.075 x 0.10	0.050 x 0.075
0.5X TV Tube	NA	0.0023	76.8 x 102	0.038	0.0047	38.4 x 51.2	0.076	0.0071	19.2 x 25.6	0.15	0.014	9.6 x 12.8	0.019	0.011	4.8 x 6.4	0.0061	0.31	0.80
	Res (lp/mm)	7	113	14	228	28	462	21	348	29	462	29	462	29	462	29	462	29
	Mag	0.063	1.0	0.13	2.0	3.0	4.0	0.25	0.38	0.50	0.67	0.80	1.0	1.3	1.6	2.0	2.7	3.6
	DOF (mm)	104	0.40	26	0.098	11	0.042	6.2	0.024	2.8	0.011	1.6	0.019	0.011	1.6	0.0061	0.31	0.80
	1/3*	57.6 x 76.8	3.60 x 4.80	28.8 x 38.4	1.80 x 2.40	19.2 x 25.6	1.20 x 1.60	0.90 x 1.20	0.60 x 0.80	0.45 x 0.60	0.30 x 0.40	0.20 x 0.27	0.15 x 0.20	0.10 x 0.15	0.075 x 0.10	0.050 x 0.075	0.0375 x 0.050	0.025 x 0.0375
0.67X TV Tube	NA	0.0023	76.8 x 102	0.038	0.0047	38.4 x 51.2	0.076	0.0071	19.2 x 25.6	0.15	0.014	9.6 x 12.8	0.019	0.011	4.8 x 6.4	0.0061	0.31	0.80
	Res (lp/mm)	7	113	14	228	28	462	21	348	29	462	29	462	29	462	29	462	29
	Mag	0.083	1.3	0.17	2.7	4.0	5.3	0.33	0.50	0.70	1.0	1.3	1.8	2.4	3.2	4.3	5.7	7.6
	DOF (mm)	104	0.40	26	0.098	11	0.042	6.2	0.024	2.8	0.011	1.6	0.019	0.011	1.6	0.0061	0.31	0.80
	1/3*	43.2 x 57.6	2.70 x 3.60	21.6 x 28.8	1.35 x 1.80	14.4 x 19.2	0.90 x 1.20	0.60 x 0.80	0.45 x 0.60	0.30 x 0.40	0.20 x 0.27	0.15 x 0.20	0.10 x 0.15	0.075 x 0.10	0.050 x 0.075	0.0375 x 0.050	0.025 x 0.0375	0.01875 x 0.025
1.0X TV Tube	NA	0.0023	76.8 x 102	0.038	0.0047	38.4 x 51.2	0.076	0.0071	19.2 x 25.6	0.15	0.014	9.6 x 12.8	0.019	0.011	4.8 x 6.4	0.0061	0.31	0.80
	Res (lp/mm)	7	113	14	228	28	462	21	348	29	462	29	462	29	462	29	462	29
	Mag	0.13	2.0	0.25	4.0	6.0	8.0	0.50	0.75	1.0	1.5	2.0	2.7	3.6	4.8	6.3	8.4	11.2
	DOF (mm)	104	0.40	26	0.098	11	0.042	6.2	0.024	2.8	0.011	1.6	0.019	0.011	1.6	0.0061	0.31	0.80
	1/3*	28.8 x 38.4	1.80 x 2.40	14.4 x 19.2	0.90 x 1.20	9.60 x 12.80	0.60 x 0.80	0.45 x 0.60	0.30 x 0.40	0.20 x 0.27	0.15 x 0.20	0.10 x 0.15	0.075 x 0.10	0.050 x 0.075	0.0375 x 0.050	0.025 x 0.0375	0.01875 x 0.025	0.01406 x 0.01875
1.5X TV Tube	NA	0.0023	76.8 x 102	0.038	0.0047	38.4 x 51.2	0.076	0.0071	19.2 x 25.6	0.15	0.014	9.6 x 12.8	0.019	0.011	4.8 x 6.4	0.0061	0.31	0.80
	Res (lp/mm)	7	113	14	228	28	462	21	348	29	462	29	462	29	462	29	462	29
	Mag	0.19	3.0	0.38	6.0	9.0	12.0	0.75	1.1	1.5	2.0	2.7	3.6	4.8	6.3	8.4	11.2	15.0
	DOF (mm)	104	0.40	26	0.098	11	0.042	6.2	0.024	2.8	0.011	1.6	0.019	0.011	1.6	0.0061	0.31	0.80
	1/3*	19.2 x 25.6	1.20 x 1.60	9.60 x 12.80	0.60 x 0.80	7.20 x 9.60	0.45 x 0.60	0.30 x 0.40	0.20 x 0.27	0.15 x 0.20	0.10 x 0.15	0.075 x 0.10	0.050 x 0.075	0.0375 x 0.050	0.025 x 0.0375	0.01875 x 0.025	0.01406 x 0.01875	0.01054 x 0.01406
2.0X TV Tube	NA	0.0023	76.8 x 102	0.038	0.0047	38.4 x 51.2	0.076	0.0071	19.2 x 25.6	0.15	0.014	9.6 x 12.8	0.019	0.011	4.8 x 6.4	0.0061	0.31	0.80
	Res (lp/mm)	7	113	14	228	28	462	21	348	29	462	29	462	29	462	29	462	29
	Mag	0.25	4.0	0.50	8.0	12.0	16.0	1.0	1.5	2.0	3.0	4.0	5.3	7.0	9.0	12.0	16.0	21.0
	DOF (mm)	104	0.40	26	0.098	11	0.042	6.2	0.024	2.8	0.011	1.6	0.019	0.011	1.6	0.0061	0.31	0.80
	1/3*	14.4 x 19.2	0.90 x 1.20	7.20 x 9.60	0.45 x 0.60	4.80 x 6.40	0.30 x 0.40	0.20 x 0.27	0.15 x 0.20	0.10 x 0.15	0.075 x 0.10	0.050 x 0.075	0.0375 x 0.050	0.025 x 0.0375	0.01875 x 0.025	0.01406 x 0.01875	0.01054 x 0.01406	0.00790 x 0.01054
Max FOV at Low Mag (Dia.)		125 mm ø	62 mm ø	42 mm ø	31 mm ø	19 mm ø	19 mm ø	19 mm ø	19 mm ø	19 mm ø	19 mm ø	19 mm ø	19 mm ø	19 mm ø	19 mm ø	19 mm ø	19 mm ø	19 mm ø

-- FOV Limited by vignetting at low mags. Approximate maximum illuminated FOV given as diameter above.

Optical Performance - Coaxial Illumination

	0.75X Objective Lens 30-37-30-000 WD: 118 mm			1.0X Objective Lens 30-37-31-000 WD: 89 mm			1.5X Objective Lens 30-37-32-000 WD: 55 mm			2.0X Objective Lens 30-37-34-000 WD: 33 mm		
	Low Mag	High Mag		Low Mag	High Mag		Low Mag	High Mag		Low Mag	High Mag	
0.375X TV Tube	NA	0.0071	0.12	0.0095	0.15	0.23	0.014	0.23	0.31	0.019	0.31	
	Res (lp/mm)	21	348	29	462	43	681	56	915	43	681	56
	Mag	0.14	2.3	0.19	3.0	0.28	4.5	0.38	6.0	0.28	4.5	0.38
	DOF (mm)	11	0.042	6.2	0.024	2.8	0.011	1.6	0.0061	0.31	0.019	0.31
0.5X TV Tube	FOV (mm) Can Format	1/3* 1/2**	25.6 X 34.1 34.1 X 45.5	1.60 X 2.13 2.13 X 2.84	1.20 X 1.60 1.60 X 2.13	1.20 X 1.60 1.60 X 2.13	1.20 X 1.60 1.60 X 2.13	1.20 X 1.60 1.60 X 2.13	1.20 X 1.60 1.60 X 2.13	1.20 X 1.60 1.60 X 2.13	1.20 X 1.60 1.60 X 2.13	1.20 X 1.60 1.60 X 2.13
	Res (lp/mm)	NA	0.0071	0.12	0.0095	0.15	0.23	0.014	0.23	0.019	0.31	
	Mag	0.19	3.0	0.25	4.0	0.38	6.0	0.50	8.0	0.38	6.0	0.50
	DOF (mm)	11	0.042	6.2	0.024	2.8	0.011	1.6	0.0061	0.31	0.019	0.31
0.67X TV Tube	FOV (mm) Can Format	1/3* 1/2** 2/3**	19.2 X 25.6 25.6 X 34.1 34.1 X 45.5	1.20 X 1.60 1.60 X 2.13 2.13 X 2.84	1.20 X 1.60 1.60 X 2.13 2.13 X 2.84	1.20 X 1.60 1.60 X 2.13 2.13 X 2.84	1.20 X 1.60 1.60 X 2.13 2.13 X 2.84	1.20 X 1.60 1.60 X 2.13 2.13 X 2.84	1.20 X 1.60 1.60 X 2.13 2.13 X 2.84	1.20 X 1.60 1.60 X 2.13 2.13 X 2.84	1.20 X 1.60 1.60 X 2.13 2.13 X 2.84	1.20 X 1.60 1.60 X 2.13 2.13 X 2.84
	Res (lp/mm)	NA	0.0071	0.12	0.0095	0.15	0.23	0.014	0.23	0.019	0.31	
	Mag	0.25	4.0	0.33	5.3	0.50	8.0	0.67	11	0.67	11	0.67
	DOF (mm)	11	0.042	6.2	0.024	2.8	0.011	1.6	0.0061	0.31	0.019	0.31
1.0X TV Tube	FOV (mm) Can Format	1/3* 1/2** 2/3**	14.4 X 19.2 19.2 X 25.6 25.6 X 34.1	0.90 X 1.20 1.20 X 1.60 1.60 X 2.13	0.90 X 1.20 1.20 X 1.60 1.60 X 2.13	0.90 X 1.20 1.20 X 1.60 1.60 X 2.13	0.90 X 1.20 1.20 X 1.60 1.60 X 2.13	0.90 X 1.20 1.20 X 1.60 1.60 X 2.13	0.90 X 1.20 1.20 X 1.60 1.60 X 2.13	0.90 X 1.20 1.20 X 1.60 1.60 X 2.13	0.90 X 1.20 1.20 X 1.60 1.60 X 2.13	0.90 X 1.20 1.20 X 1.60 1.60 X 2.13
	Res (lp/mm)	NA	0.0071	0.12	0.0095	0.15	0.23	0.014	0.23	0.019	0.31	
	Mag	0.38	6.0	0.50	8.0	0.75	12	1.0	16	1.0	16	1.0
	DOF (mm)	11	0.042	6.2	0.024	2.8	0.011	1.6	0.0061	0.31	0.019	0.31
1.5X TV Tube	FOV (mm) Can Format	1/3* 1/2** 2/3**	9.60 X 12.8 12.8 X 17.1 17.1 X 22.8	0.60 X 0.80 0.80 X 1.07 1.07 X 1.44	0.60 X 0.80 0.80 X 1.07 1.07 X 1.44	0.60 X 0.80 0.80 X 1.07 1.07 X 1.44	0.60 X 0.80 0.80 X 1.07 1.07 X 1.44	0.60 X 0.80 0.80 X 1.07 1.07 X 1.44	0.60 X 0.80 0.80 X 1.07 1.07 X 1.44	0.60 X 0.80 0.80 X 1.07 1.07 X 1.44	0.60 X 0.80 0.80 X 1.07 1.07 X 1.44	0.60 X 0.80 0.80 X 1.07 1.07 X 1.44
	Res (lp/mm)	NA	0.0071	0.12	0.0095	0.15	0.23	0.014	0.23	0.019	0.31	
	Mag	0.56	9.0	0.75	12	1.1	18	1.5	24	1.5	24	1.5
	DOF (mm)	11	0.042	6.2	0.024	2.8	0.011	1.6	0.0061	0.31	0.019	0.31
2.0X TV Tube	FOV (mm) Can Format	1/3* 1/2** 2/3**	6.40 X 8.53 8.53 X 11.4 11.4 X 15.6	0.40 X 0.53 0.53 X 0.71 0.71 X 0.98	0.40 X 0.53 0.53 X 0.71 0.71 X 0.98	0.40 X 0.53 0.53 X 0.71 0.71 X 0.98	0.40 X 0.53 0.53 X 0.71 0.71 X 0.98	0.40 X 0.53 0.53 X 0.71 0.71 X 0.98	0.40 X 0.53 0.53 X 0.71 0.71 X 0.98	0.40 X 0.53 0.53 X 0.71 0.71 X 0.98	0.40 X 0.53 0.53 X 0.71 0.71 X 0.98	0.40 X 0.53 0.53 X 0.71 0.71 X 0.98
	Res (lp/mm)	NA	0.0071	0.12	0.0095	0.15	0.23	0.014	0.23	0.019	0.31	
	Mag	0.75	12	1.0	16	1.5	24	2.0	32	2.0	32	2.0
	DOF (mm)	11	0.042	6.2	0.024	2.8	0.011	1.6	0.0061	0.31	0.019	0.31
Max FOV at Low Mag (Dia.)	FOV (mm) Can Format	1/3* 1/2** 2/3**	4.80 X 6.40 6.40 X 8.53 8.53 X 11.4	0.30 X 0.40 0.40 X 0.53 0.53 X 0.71	0.30 X 0.40 0.40 X 0.53 0.53 X 0.71	0.30 X 0.40 0.40 X 0.53 0.53 X 0.71	0.30 X 0.40 0.40 X 0.53 0.53 X 0.71	0.30 X 0.40 0.40 X 0.53 0.53 X 0.71	0.30 X 0.40 0.40 X 0.53 0.53 X 0.71	0.30 X 0.40 0.40 X 0.53 0.53 X 0.71	0.30 X 0.40 0.40 X 0.53 0.53 X 0.71	0.30 X 0.40 0.40 X 0.53 0.53 X 0.71
	Res (lp/mm)	NA	0.0071	0.12	0.0095	0.15	0.23	0.014	0.23	0.019	0.31	
	Mag	0.75	12	1.0	16	1.5	24	2.0	32	2.0	32	2.0
	DOF (mm)	11	0.042	6.2	0.024	2.8	0.011	1.6	0.0061	0.31	0.019	0.31

-- FOV limited by illumination at low mags. Approximate maximum illuminated FOV given as diameter above.



Objective Lenses

Mandatory for operation of your Zoom 160 System, Objective Lenses attach to the Lower Modules and are available in a variety of magnifications to further expand Zoom 160's imaging capabilities.

08

For all part numbers, ordering information and configuration options (refer to [Zoom 160 Lens System Diagram p. 10-11](#)).

0.5X OBJECTIVE LENS
W.D. 389.7 MAX

0.5X OBJECTIVE LENS
W.D. 181.3 MAX

NOTES:

1. MAGNIFICATION (1X OBJECTIVE, 1X TUBE) = 0.5X THRU 8.0X
 2. NA (1X OBJECTIVE, 1X TUBE) = 0.009 THRU 0.150
 3. FIELD COVERAGE DEPENDS ON OBJECTIVE LENS, ZOOM SETTINGS, ADAPTER AND CAMERA FORMAT.
 4. ADD 19.1 TO OVERALL DISTANCE FOR FINE FOCUS AND 58.6 FOR COAX MODELS.
5. AN OBJECTIVE LENS IS REQUIRED FOR IMAGE FORMATION.
6. ALL DIMENSIONS IN mm UNLESS NOTED.

Zoom 160 Dimensional Schematic

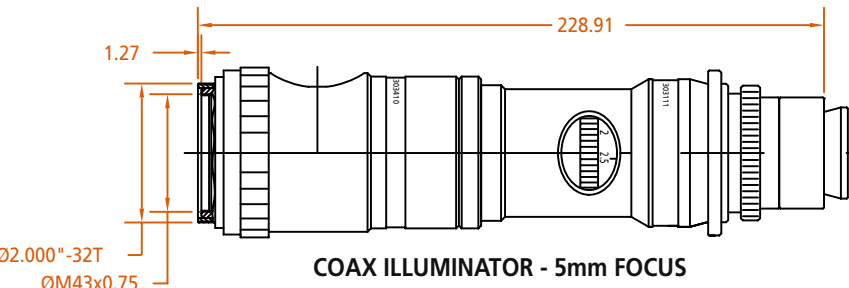
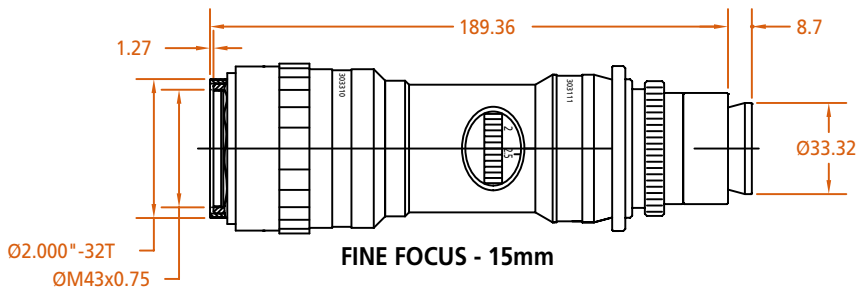
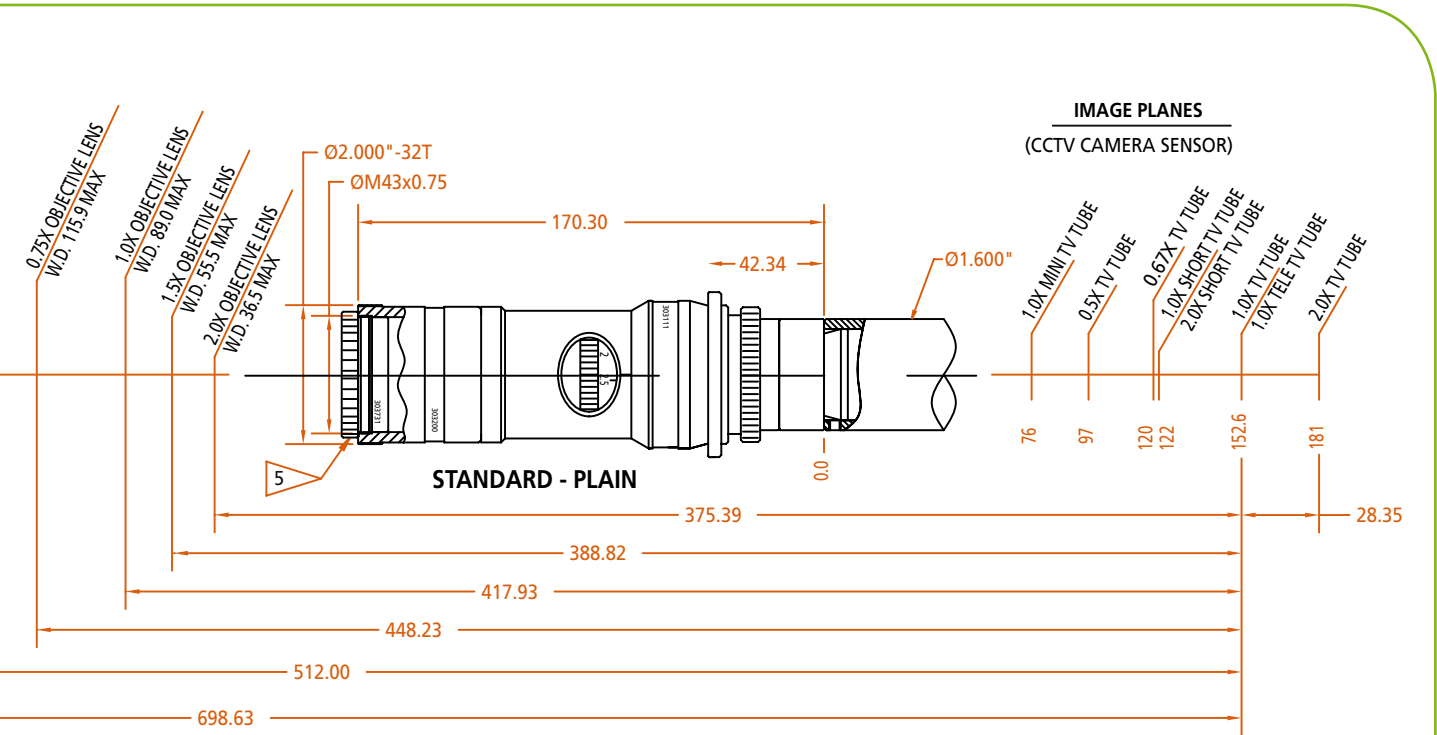

Zoom 160 System Diagram

10

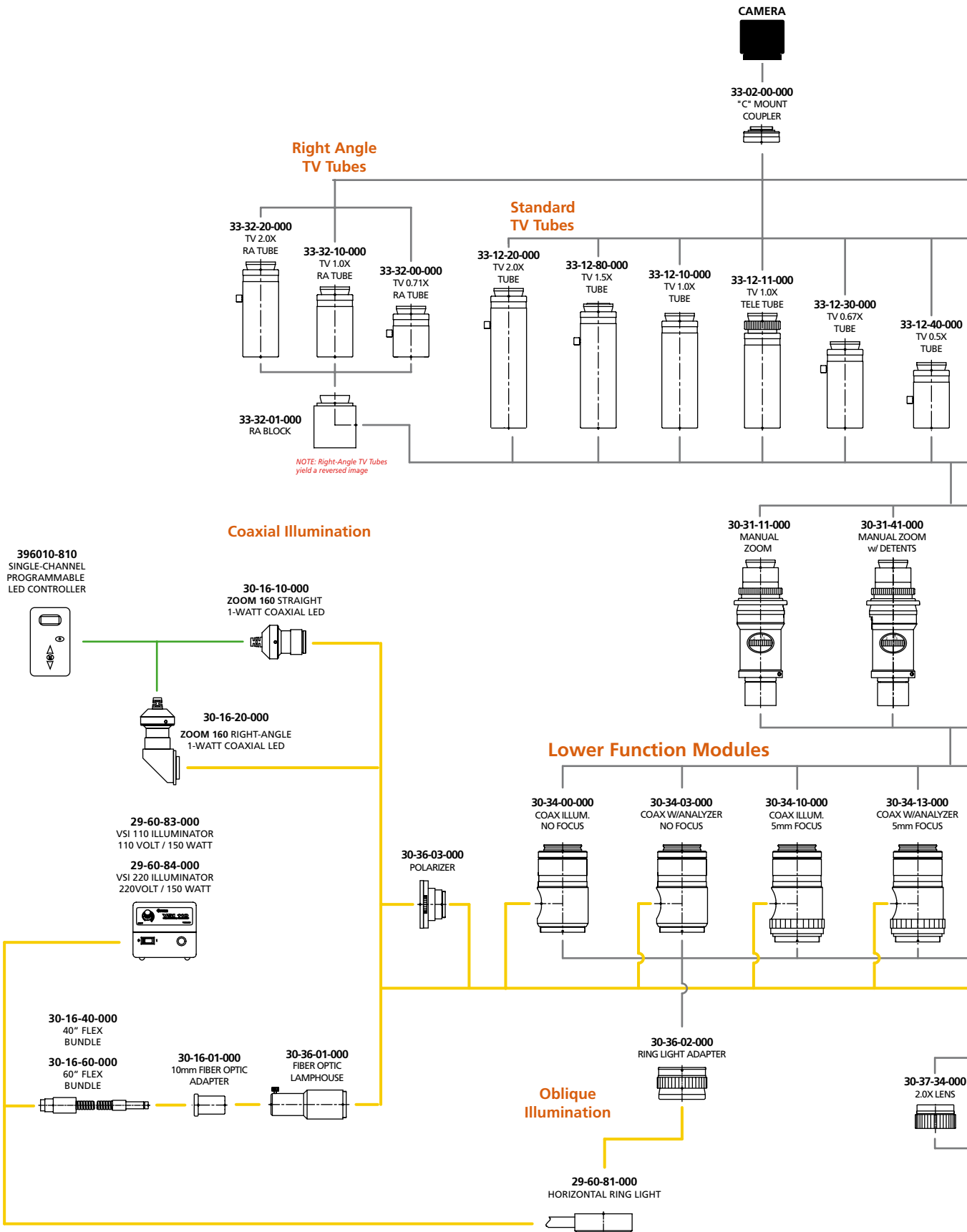

Short and Mini TV Tubes

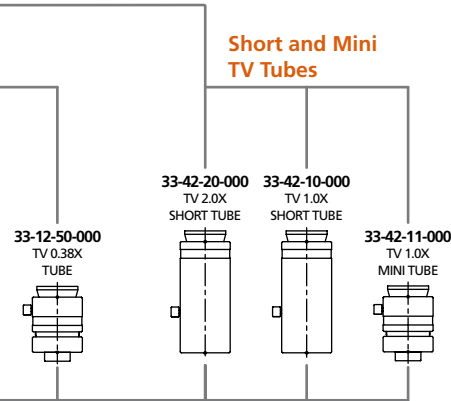

Upper Zoom Modules

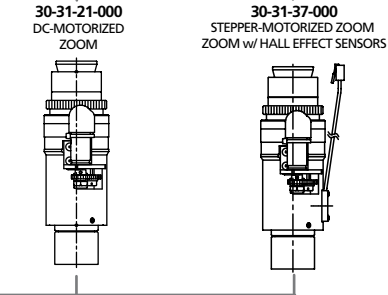

Manual Mounting

30-35-76-000
76mm O.D.
FLANGE MOUNT
(OLYMPUS, NIKON & LEICA)

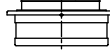

30-35-82-000
82mm O.D.
FLANGE MOUNT (UNITRON)

30-35-83-000
83mm O.D.
FLANGE MOUNT

30-35-84-000
84mm O.D.
FLANGE MOUNT (MEIJ)

30-35-00-000
FLANGE FLAT MOUNT

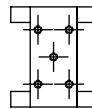

(Manual Zooms ONLY)

Motorized Mounting

30-45-06-000
76mm O.D.
TUBE CLAMP



30-45-02-000
82mm O.D.
TUBE CLAMP

30-45-03-000
83mm O.D.
TUBE CLAMP

30-45-04-000
84mm O.D.
TUBE CLAMP

30-35-34-000
MOTOR FLAT MOUNT

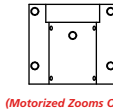

(Motorized Zooms ONLY)

Motor Controls & Power Supply

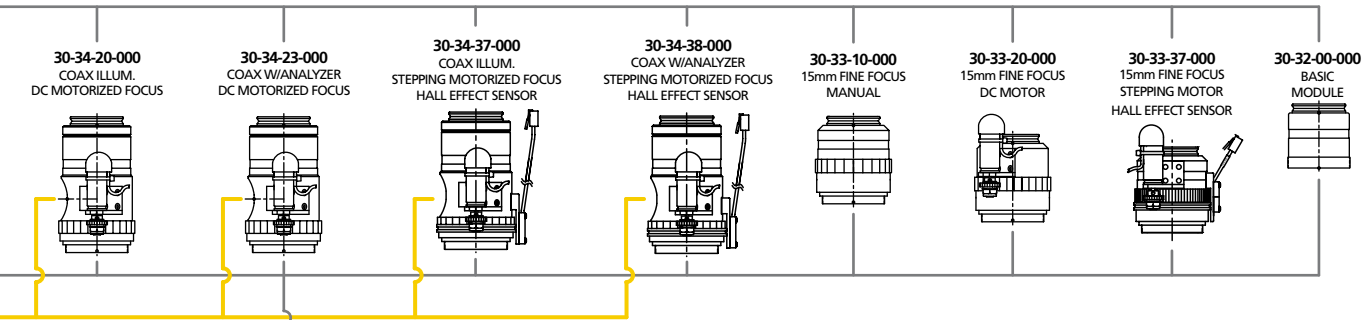
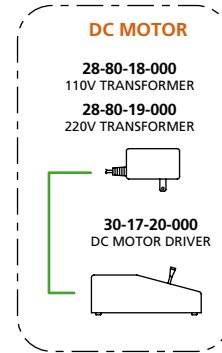
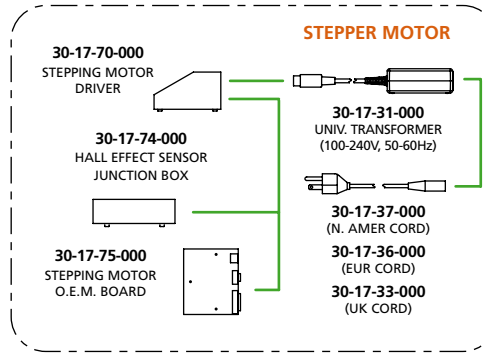

Objective Lenses

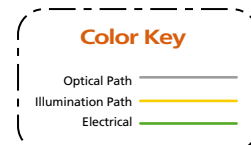
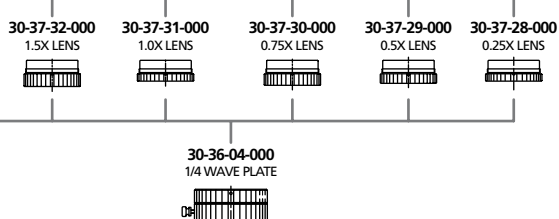



Your Key to Photonic Innovation...

Qioptiq serves a wide variety of applications across the industrial manufacturing sector. With a rich history of delivering innovative photonic components, modules and instruments to integrators, engineers and OEMs, we also offer custom-tailored photonic solutions to maximize the potential and capabilities of tomorrow's many processes and industrial manufacturing systems.

...and Manufacturing Advancement

For technical information

Qioptiq
www.qioptiq.com
photonics@qioptiq.com

North America
Qioptiq, Inc.
Fairport, NY USA
Toll free: 800-724-4274
Tel: (585) 223-2370

Europe
Qioptiq Photonics GmbH
Göttingen, Germany
Tel: +49 551 6935-0

Asia Pacific
Qioptiq Pte Ltd.
Singapore
Tel: +65 6499 7766

